

MERCATOR ikuü

app features

- Rooms**
Separate your products within the app for easy control based on their location.
- Alerts**
Manage the kinds of alerts you receive from your products.
- Sharing**
Share access of your products with others.
- In-App Customer Service**
Talk to our customer service team directly through the app if you have any issues.

MERCATOR ikuü

explore the range



Want more Mercator Ikuü? Visit ikuu.com.au to explore our whole range of smart products!

For guides on using these features in the app and to see our broad range of smart products, visit www.ikuu.com.au

You can speak to our customer service team directly via phone on **1300 552 255 (AU)** or **0800 003 329 (NZ)**, or via email at customercare@mercator.com.au

MRIN007127

MERCATOR ikuü

installation instructions

1 Introduction

This lock requires a 54mm diameter main bore, as well as a door thickness of 35-54mm and a backset of 60mm or 70mm.

If you are replacing an existing lock, remove the lock and latch completely before proceeding.

For new installations, use a door lock installation kit (not included) to create the main bore, cross bore and face plate cut-outs.

Install the provided strike plate and box to the frame of your door.

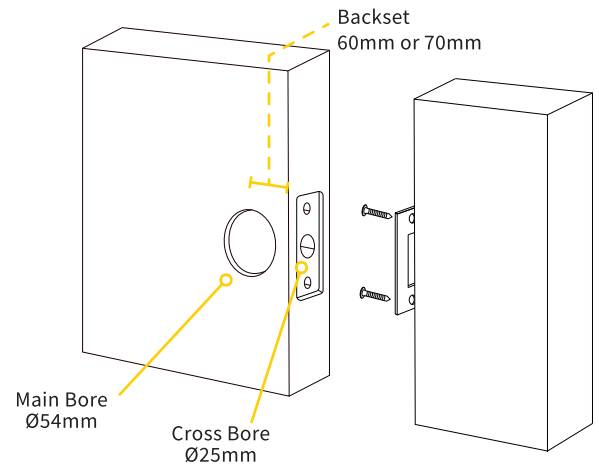

2 Installation

1. Viewing your door from the **outside**, check whether your hinge is on the left or right side of the door. This lock is configured for right-hinged doors by default, skip to step 3 if you have a right-hinged door.

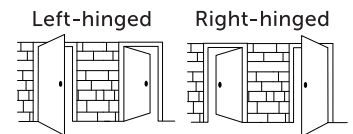

2. If you have a left-hinged door, you will need to adjust the handle direction on both the external and internal panels. For each panel, remove the screw next to the back of the handle and rotate the handle up and around before reinstalling the screw.

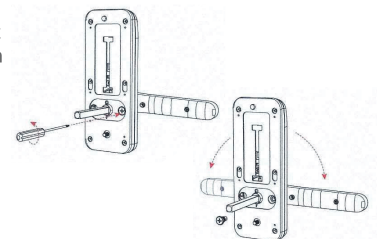

2 Installation (Cont.)

3. Check that the adjustable latch is set to the correct backset for your installation, then install the included latch and strike plate to your door using the provided screws. The latch should be oriented so that it will automatically retract as it hits the strike plate.

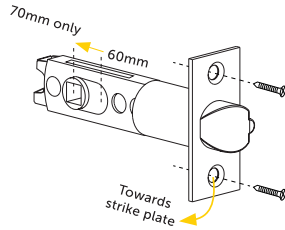

4. Select the correct accessory kit based on your door thickness as marked (35-44mm or 45-54mm). Install the spindle and 3 standoffs to the external panel, and secure the spindle in place using the provided pin. Ensure that the rubber seals are attached to the back of both the external panel and mounting plate. Install the external panel through the latch and use the 3 provided M4 screws to secure it to the mounting plate.

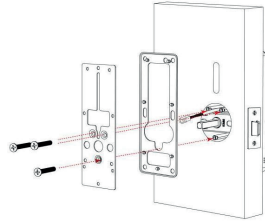

5. Remove the battery cover from the internal panel using the notches on the side of the lock. Connect the wires between the two panels, then fit the internal panel to the mounting plate and secure with 3 M3*10mm screws. Install 4 new AA batteries and replace the battery cover.

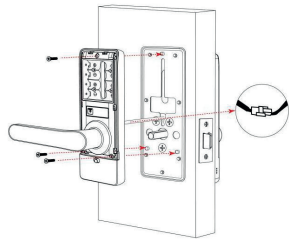

Secure lock switch

WARNING: Before pairing, your door lock can be opened with any fingerprint or keypad input.

The switch on the internal panel can be used to lock your door, which can then be unlocked using the physical keys provided.

After pairing, your lock can be set to lock automatically after a set period of time, and it is not necessary to manually lock the door using the switch. The switch instead activates a secure mode, which temporarily deactivates non-administrator fingerprints, tags and codes. The lock will only be accessible to administrators, Bluetooth unlocking and physical keys in this mode.

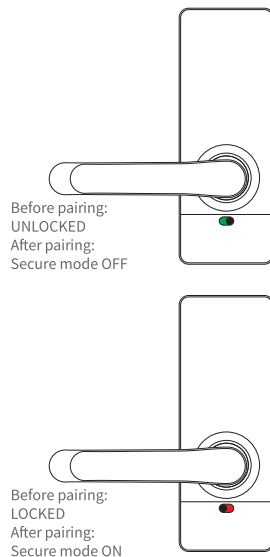

MERCATOR ikuü

pairing instructions

1 Set Up the App

1. Download the Mercator Ikuü app.
2. Tap 'create new account' or 'log in to account'.
3. Follow the in-app prompts and tap 'OK'.

2 Connect to the App

Pairing Your Product:

1. Open the Mercator Ikuü app.
2. With the door unlocked from the internal switch, wake the keypad by pressing against it with the back of your hand. If your lock is in pairing mode, it will ask you to pair the device. If there is no voice prompt, follow the instructions in the next section to reset your device.
3. Tap + > Add Device > Auto Scan. The discovery process will begin.
4. When your product is discovered, tap 'next'.
5. Once pairing is complete, you can edit the name of your product.
6. To finish the pairing process, tap 'done'.

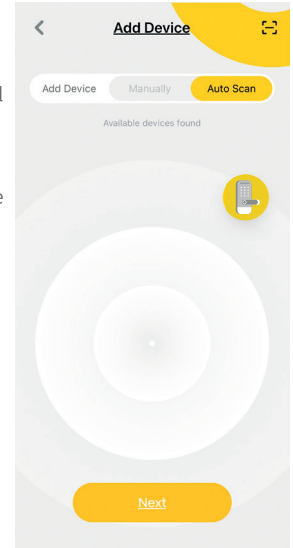

3 Reset your device

1. Remove the battery cover from the internal panel using the notches on the side.
2. Remove at least one of the batteries from the lock and keep it nearby.
3. Use a pin to press and hold the reset button, then reinstall the battery while holding the reset button down. Continue holding while the lock counts down from 5 until the reset is confirmed.

